

Technical Data

Power: DC 12V/2.0A
 Operating Systems:
 2000/XP/Vista/Win7/Win8
 Mac OS X

Features

- 2.5" / 3.5" SATA Hard Drive Docking Station
- USB 3.0 transfer rates up to 5Gbps
- Plug & Play, Hot Swappable
- Supports 2.5" & 3.5" SATA HDD up to 4TB

Parts

- 1-Hard Drive Slots
- 2-Power LED
- 3-Power Switch
- 4-Hard Drive Eject Button
- 5-USB 3.0 Cable Interface
- 6-Power Cable Interface

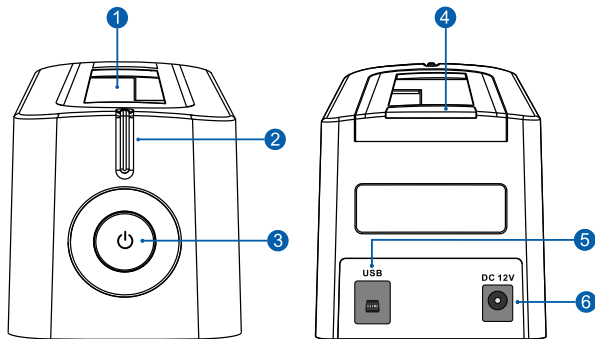

USB 3.0 SATA 2.5" & 3.5" HARD DRIVE DOCKING STATION



1. Check your Hard Drive to make sure it has the correct connector. This dock supports SATA only.

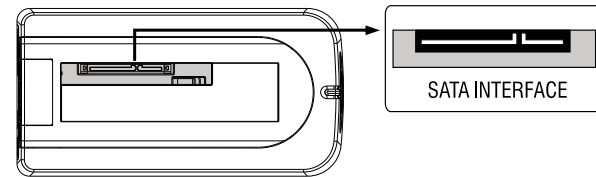

2. Insert the Hard Drive into the dock. The Eject Button will pop up when the Hard Drive is inserted fully.

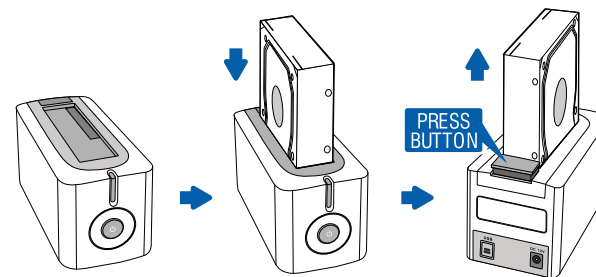

3. Next, connect the Power Adapter to a wall socket. Then, connect the USB cable from the Dock to the Computer.

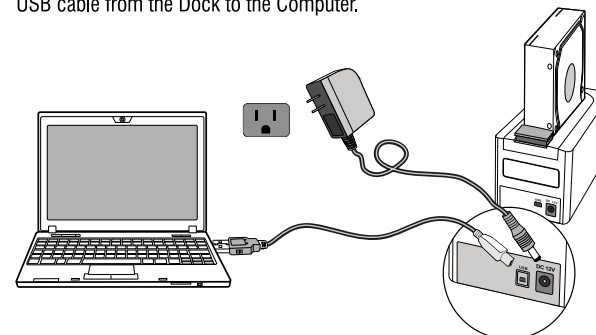

USB 3.0 SATA 2.5" & 3.5" HARD DRIVE DOCKING STATION



Package Contents

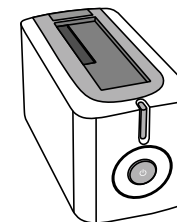

HARD DRIVE DOCK

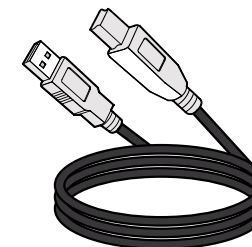

USB 3.0 CABLE

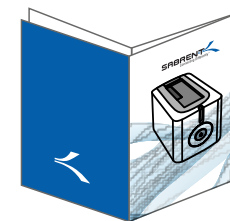

USER MANUAL

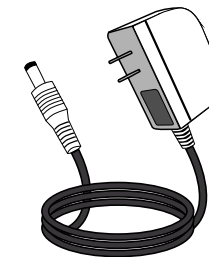

POWER ADAPTER

